

S U P P L Y I N G   C L E A N   A I R   T O   I N D U S T R Y

*New!*   M O D E L   2M660

## Vertical Oil Mist Collector



*The new 2M660 from Air Quality Engineering, Inc., is a self-contained media air cleaning system designed for source capturing coolant mist applications in industry. The 2M660 can be ordered in three stage filtration which will effectively remove a broad range of contaminants including mist, smoke, soot, vapors, VOC's and more at a rate of up to 6000 cfm.*

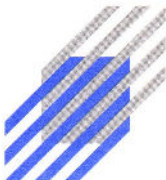

**AIR QUALITY  
ENGINEERING**

7140 Northland Drive North, Brooklyn Park, MN 55428-1520 USA  
**EMAIL:** [info@air-quality-eng.com](mailto:info@air-quality-eng.com) **WEB SITE:** [www.air-quality-eng.com](http://www.air-quality-eng.com)  
**TOLL FREE:** 1-800-328-0787  
**PHONE:** 763-531-9823

Air Quality Engineering Inc., has a policy of continuing product improvement and reserves the right to make changes in design and specification without notice.

Before you get started please review the following:

Purchase Date: \_\_\_\_\_

Serial Number: \_\_\_\_\_

Motor Spec: \_\_\_\_\_

Belt and Sheave Used: \_\_\_\_\_

Type of oil / coolant collected: \_\_\_\_\_

Type of filter and AQE P/N: \_\_\_\_\_

### Customer Technical Support:

To contact Air Quality Engineering use:

Mail: Air Quality Engineering  
7140 Northland Drive N.  
Brooklyn Park, MN 55428  
USA

Phone: 1.800.328.0787  
763.531.9823

Fax: 763.531.9900

e-mail: [info@air-quality-eng.com](mailto:info@air-quality-eng.com)

web: [www.air-quality-eng.com](http://www.air-quality-eng.com)

#### Copyright

Air Quality Engineering, Inc. copyrights this manual with all rights reserved. Under the copyright laws, this manual may not be reproduced in any form, in whole or in part, without the prior written consent of Air Quality Engineering, Inc.

© 2006

#### Disclaimer

All statements, technical information and recommendations in this manual or related documents are believed reliable, but the accuracy and completeness thereof are not guaranteed or warranted, and they are not intended to be, nor should they be understood to be representation or warranties concerning the products described.

Specifications are subject to change without notice.

*This unit is to be used exclusively for source control in industrial applications in California.*

# TABLE OF CONTENTS

	PAGE
HOW AIRBORNE CONTAMINATION IS REMOVED	3
DIMENSIONS	4
SPECIFICATIONS	5
PLANNING THE INSTALLATION	6
ASSEMBLY	7
CHECKOUT AND OPERATION	8
ADJUSTMENTS	9
MAINTENANCE	10
ELECTRICAL SCHEMATICS	11
PARTS IMAGES	12
PARTS LIST	13
TROUBLESHOOTING	14
WARRANTY	15

## HOW AIRBORNE CONTAMINATION IS REMOVED

Dirty air passes through the prefilter. The prefilter removes large particulate, such as lint. The primary filter then captures the remaining smaller particulate. As the contaminant load on the filters increases, the filters become more efficient in capturing the smaller particles. At the same time, however, the dirty filter allows less particle collection and a decrease in the overall effectiveness of the air cleaner.

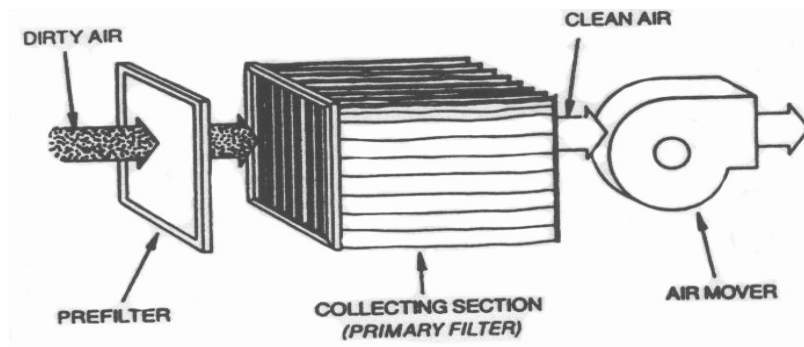

# DIMENSIONS

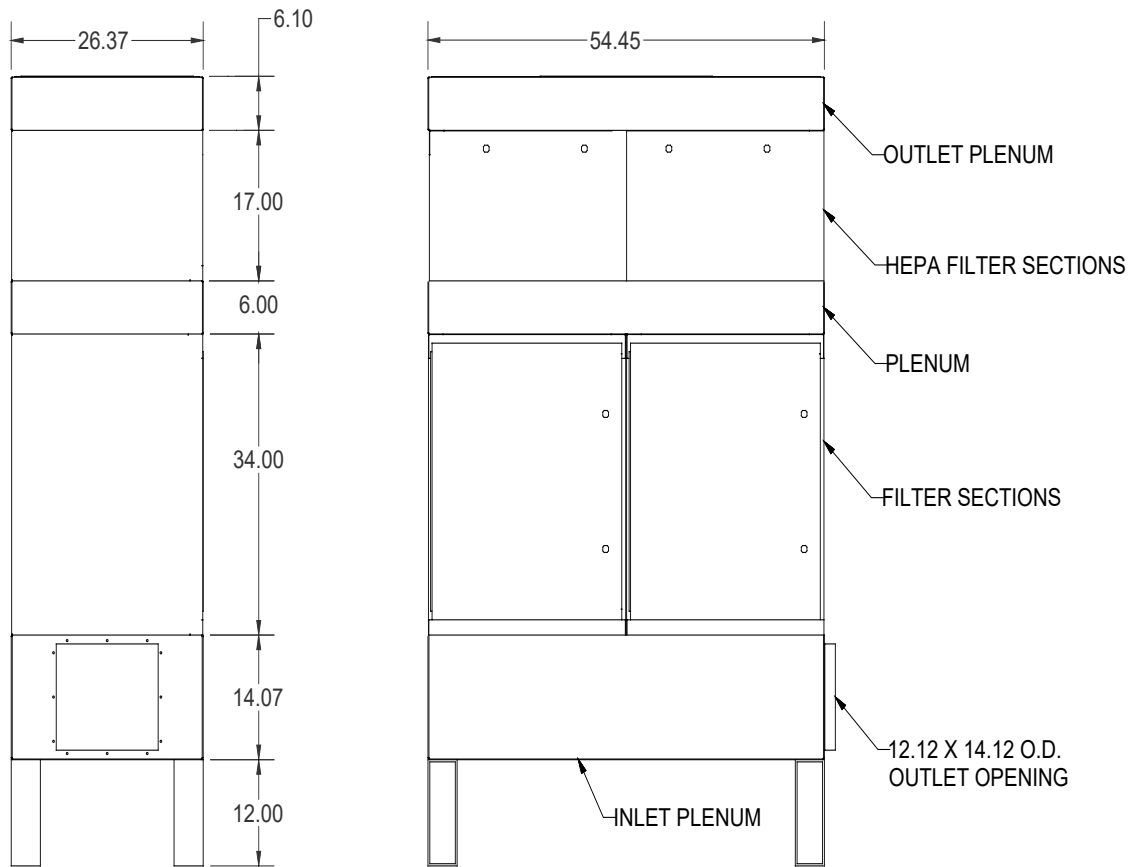

METRIC CONVERSION	FORMULA
Ins. to mm	Ins. x 25.4
Lbs. to kgs.	Lbs. x .455
Ins. w.g. to kPa	Ins. w.g. x .2488
CFM to m <sup>3</sup> /h	CFM x 1.6992
Ft <sup>2</sup> to m <sup>2</sup>	Ft <sup>2</sup> x .0929

# SPECIFICATIONS

## - IMPORTANT -

**THE SPECIFICATIONS GIVEN IN THIS PUBLICATION DO NOT INCLUDE NORMAL MANUFACTURING TOLERANCES. THEREFORE, THIS UNIT MAY NOT MATCH THE LISTED SPECIFICATIONS EXACTLY. ALSO, THIS PRODUCT IS TESTED AND CALIBRATED UNDER CLOSELY CONTROLLED CONDITIONS AND SOME MINOR DIFFERENCES IN PERFORMANCE CAN BE EXPECTED IF THOSE CONDITIONS ARE CHANGED.**

### SPECIFICATIONS

- Dimensions: 89"H x 55"W x 26 ¼"L
- Weight: 360 Lbs. installed weight    430 Lbs. shipping weight
- Cabinet: 16 gauge welded steel cabinet with a powder coat finish. Built-in sump and drain connection for oil mist removal.
- Standard Motor: 1 HP, ball bearing
- Standard Blower: Forward curved, sleeve bearing, belt driven, centrifugal blower, capable of moving 4600 CFM free air.
- Instrumentation: Dirty Filter Gauge – Factory installed pressure gauge designed to determine filter replacement cycle.  
Indicator Light – Light indicates that the blower motor is energized properly.
- Noise Levels: With 1 HP motor @ 9 feet = 67 dBa, @ 15 feet = 66 dBa
- Power Input:

Vac, Hz, Ph	Amps					
	1 Hp	2 Hp	3 Hp	2 Hp BI	3 Hp BI	5 Hp BI
120, 60, 1	12	NA	NA	NA	NA	NA
208-240, 60, 1	6.6	9	NA	NA	NA	NA
208-240, 60, 3	3.8	7	9	5.9	8.6	13.3
440-480, 60, 3	1.9	3.5	4.4	2.9	4.3	6.6

### CFM:

Static Pressure (inches of water)	Airflow (cubic feet per min)					
	1 Hp FC	2 Hp FC	3 Hp FC	2 Hp BI	3 Hp BI	5 Hp BI
1.5	1800	2850	3500	2200	3700	4100
2	1400	2500	3250	2100	3600	3900
3	850	2000	2700	1900	3200	3700
4		1450	2150	1700	2800	3500
5				1400	2400	3200
6				1100	1800	2800
7						2600
8						2300

### FILTER OPTIONS

**Pre-filter:** Two 24" x 24" x 2" aluminum mesh grease impingers.

**Primary Filter Options:** See Parts List

Air Quality Engineering, Inc., has a policy of continuing product improvement and reserves the right to make changes in design and specifications without notice.

# PLANNING THE INSTALLATION

## **- WARNING -**

The M66O source capture Media Air Cleaner is not explosion-proof. It must not be installed where there is danger of vapor, gas or dust explosion.

### **INTRODUCTION**

Clean air is the subject of numerous laws and regulations. Typical requirements in the United States are those put out by the Occupational Safety and Health Administration (OSHA). Private groups, such as the American Society of Heating, Refrigeration and Air Conditioning Engineers (ASHRAE), have also published numerous recommendations.

Normally, clean air is defined in regulations and recommendations as air having a limited amount of contaminant in it, commonly expressed as parts per million or milligrams per cubic meter. Approved counteractions are intended to lower or eliminate the amount of contaminants in the air. One of the more common methods of achieving this goal is through the use of media air cleaners.

At no time should a media air cleaner be placed where there is a potential for explosion due to the presence of explosive dusts, gases or vapors. Contact the nearest Air Quality Engineering, Inc., representative for assistance in determining the correct application of a media air cleaner.

### **SIZING**

Sizing is the process of determining the amount of air cleaning necessary in any given application. Since the 2M66O is a source capture air cleaner, the sizing process is relatively simple—provide one source capture hood per contaminant source.

If air contaminants are generated from fixed stations where hoods and hoses can be acceptably installed, cleaning the air by capturing the contaminant at the source is strongly recommended. For source capture air cleaning, a hood (not provided) is installed where the contaminants are generated and an attached hose feeds the contaminants to a source capture plenum. The plenum transfers the contaminants from up to two hoses directly into the media air cleaner (hoses are ordered as accessories).

The composition, quantity and rate of generation of the contaminants determines the air velocity in turn not only affects the hood design and location but it also sets limits on how much hose can be

used before the air pressure drop becomes too great for effective contaminant capture.

Therefore, when sizing an application for source capture air cleaning, it is necessary to keep in mind how the specific contaminants, the hood and the needed velocity all combine to affect the number of stations which can be attached to a single unit and the number of units which will be needed for a particular application.

### **SOURCE CAPTURE CLEANING**

When selecting a location for a media air cleaner that uses a hood and hose to capture the contaminants at the source choose the location that will keep the air pressure drop caused by the length of the hose within an acceptable range. Do not mount the outlet of the air cleaner so close to a wall that it inhibits the airflow. Also, the outlet of an air cleaner should not be located such that it interferes with the source capture process of another air cleaner hood.

To effectively control atmospheric contamination at its source, proper hood design is necessary. Minimum airflow and power consumption are also important factors in designing an effective local exhaust system to control contamination. Capturing air contaminants at their source requires the creation of sufficient airflow past the contaminant source to remove the contaminated air and draw it into an exhaust hood. Fine airborne dust particles, mist, vapors, gases and fumes follow air currents. Airflow alone is sufficient to capture these contaminants.

Basic knowledge of the contaminated airflow to be controlled is necessary before an effective hood or enclosure can be designed. The more complete and effective the design, the more economical and efficient the installation will be.

A complete enclosure is often the best way to start. Once a source is ideally enclosed, provide access and working openings as required. This concept can be used to develop booths, side- or downdraft hoods and side shields.

The access and working openings must be kept to a minimum. Whenever possible, they must also be kept away from the contaminated airflow. Any inspection and maintenance openings should be provided with tight doors whenever possible.

A hood that is open and does not enclose or confine the contaminant should be avoided. Open

hoods can be used but exhaust volumes must be large and cross drafts nearby can easily upset draft control.

Canopy hoods are effective in controlling operations that may suddenly release surges of gases and vapors. Hot processes are an example.

However, canopies should not be used where people may be working in the airflow between contaminant source and canopy because exhaust airflow can actually increase the worker's exposure to the contaminant. Plating tanks and cementing tables typically have this problem with canopy-type hoods.

The duct takeoff in the exhaust hood should be located in the normal line of contaminant travel. Arrange the duct openings to distribute the exhaust airflow throughout the hood. This is especially important with large, shallow hoods where air movement tends to concentrate close

the duct opening. The airflow can be spread around the hood by using multiple duct takeoffs, interior baffles or filter banks.

Air intake from areas not needing airflow or without contaminants can be controlled with flanges. Flanges minimize airflow from areas outside the desired air collection area. Usually the flange width is equal to the hood diameter but not exceeding six inches (152.4 mm). Flanges may increase the effectiveness of the hood allowing a reduction in hood airflow requirements by up to 25 percent.

Exhaust airflow requirements are calculated after the hood design is determined. The airflow volume is calculated using the enclosure's known open area and the airflow velocity needed to collect the contaminants. The collected airflow must be sufficient to prevent the escape of any contaminated air.

## ASSEMBLY

### - CAUTION -

Do NOT connect the power source until after the air cleaner is completely assembled.

If the air cleaner must be turned on for an electrical check, be extremely careful in avoiding electrical shock. Also, take care to avoid the air cleaner's moving parts.

### WHEN ASSEMBLING THIS PRODUCT

Read these instructions carefully. Failure to follow them could damage the product or cause a hazardous condition.

Check the electrical ratings given on the air cleaner schematic to the power source to insure compatibility.

After assembly is complete, check out the product operation as provided in these instructions.

### UNPACKING

Remove all shipping cardboard and banding. Be sure to inspect the packaging material before discarding it.

### ASSEMBLING THE M660

Unit should be securely anchored to the floor to prevent the unit from tipping.

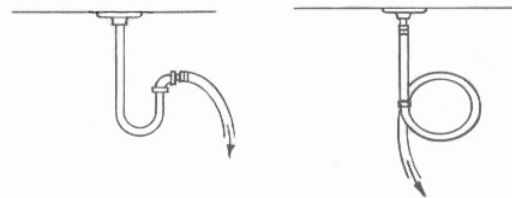

Your 2M660 comes standard with a drain fitting. Simply connect hose to the  $\frac{3}{4}$ " NPT drain fitting and pipe to a suitable collection tank. A trap must be installed in the drain line with at least an 8" rise or 8" diameter loop (see diagram). Prime trap with liquid that will be collected to break air suction in filter compartment when air cleaner is operating.

### WIRING

The 2M660 has no special wiring requirements. It comes equipped with a 10-foot power cord and plug. The power source must be compatible with the voltage and frequency of the 2M660. The rating on the 2M660 is located on the schematic on the inside of the filter access door. Route the power cord so that it is out of the way of the building's occupants. Do not use an extension

cord.

# CHECKOUT AND OPERATION

## CHECKOUT

Before operating the M66O, check out the installation using the following procedures:

1. Make sure the air cleaner is oriented for good air circulation where it will not interfere with personnel and material traffic. Keep out of fire lanes and away from overhead cranes.
2. Make sure the prefilter and the primary filter are properly oriented and the airflow arrows are pointing toward the blower. Make sure the hoops on the primary filter are all attached to the rings.
3. (OPTIONAL) Make sure the manometer gauge is level. See the spirit level in the right hand corner of the gauge. If not make sure the unit is level. Or if minihelic installed on unit make sure minihelic is at zero inches of water. If not, reference calibration of the minihelic.
4. (OPTIONAL) Check the oil level is at zero inches of water when the M66O is turned off. If not, reference calibration of the manometer or minihelic.

## OPERATION

1. Turn on the air cleaner control switch. Make sure the blower is providing a strong air discharge. Please note that the M66O airflow was factory-set at the maximum, considering the filter efficiency and other options ordered, such as impingers plenums and carbon.
2. (OPTIONAL) The filter gauge should be level and should read zero when the M66O is turned off.

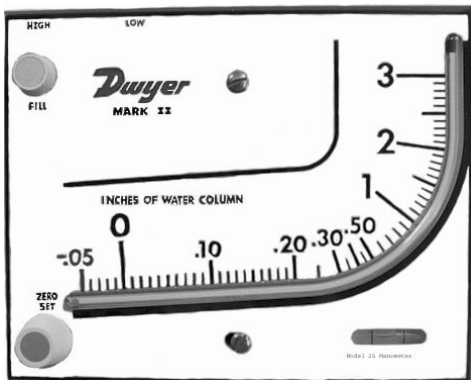

(OPTIONAL)

### CALIBRATION OF THE DWYER FILTER GAUGE

After the air cleaner has been installed and is ready for operation, the air filter gauge must be calibrated. See the following simple steps:

#### Step 1

Check that the filter gauge is level. See the spirit level in the right hand corner of the gauge.

#### Step 2

Check the red oil level and adjust the zero knob so that the oil level is at zero inches of water when the air cleaner is turned off.

#### Step 3

Turn the air cleaner on with the clean filters in place. Place the green arrow adjacent to the point at which the red oil rises. The green arrow will indicate clean filters.

#### Step 4

Place the red arrow on the gauge scale one inch higher (according to the scale) than the green arrow. This will indicate dirty filters. A one-inch rise in static pressure indicates a reduction in airflow of approximately twenty-five percent.

(OPTIONAL)

### CALIBRATION OF THE MINIHELIC

Zeroing hex screw

#### Step 1

Remove the plastic cover by turning it counter-clockwise. One may have to press on the cover as one is turning it.

#### Step 2

With the supplied hex wrench, one can adjust the needle by turning the hex screw at the bottom of the gauge.

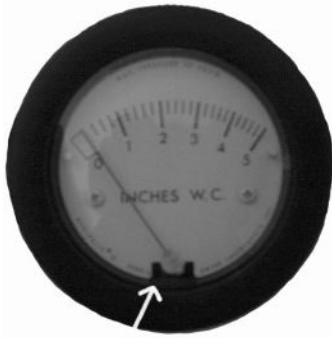

## MAINTENANCE

### - CAUTION -

Always disconnect the power to the M66O before working on or near the air cleaner.

#### FILTER MAINTENANCE/REPLACEMENT

Dirty air passes through the prefilter. The prefilter removes large particulate. The primary filter then captures the remaining particulate.

As the contaminant load on the filters increases, the filters become more efficient in capturing the smaller particles. At the same time, however, the dirty filter allows less air to pass through resulting in less particle collection and a decrease in the overall effectiveness of the air cleaner.

The 2M66O Air Cleaner is equipped with a pressure gauge which indicates the restriction to airflow caused by the filters loading with particulate. When the air filter gauge reaches the red arrow or a noticeable reduction in airflow occurs, it is time to clean or replace the prefilter and possibly the primary filter.

**NOTE: An increase of one inch on the gauge would be approximately a 25% decrease in airflow. If the reduction in airflow is not a problem, the air cleaner can be operated beyond this point. The red arrow can be moved to the point at which the decrease in airflow becomes a problem.**

#### Step 1

Turn off the air cleaner. Open up the filter access doors and slide out the prefilter.

#### Step 2

Replace the prefilter and turn on the air cleaner. The reading on the air filter gauge should be at or near the green arrow. If no performance improvement is evident after cleaning or replacing

the prefilter, the primary filter will have to be replaced. In most cases, the prefilter can be replaced several times before the primary filter will need to be replaced.

#### Step 3

Replace the primary filter with the access door open, remove the hoops from the retainers. The retainers should remain attached to the blower grill. The filter then can be removed by sliding it out along the tracks. A new primary filter can be replaced with the process reversed.

#### Optional Step 3

When a carbon filter is in place and the extended service filter is used the retainers are not necessary and should be ignored. The extended service filter can be removed by sliding it out along the tracks. A new extended service filter can be replaced into the tracks.

#### (OPTIONAL)

#### MANOMETER GAUGE MAINTENANCE

Check the oil level occasionally and adjust the zero knob as required. Be sure all pressure is removed by turning the air cleaner off before adjusting the zero knob. If it becomes necessary to add more oil to the gauge, be certain to use only Dwyer Red Oil that is provided with the air cleaner. Other fluids may damage the gauge. To fill the gauge first max out (turn clockwise) the zero adjust knob (lower left). Unscrew the fill cap (upper left). Pour in oil. Oil is thick so be patient. Screw back on the fill cap. If oil is past the zero level back out (turn counter clockwise) the zero adjust knob.

Clean the gauge with a soft cloth using a little pure soap and water. Use of a small brush will aid in cleaning the knobs. Avoid cleaning fluids and liquid soaps, which may have chlorinated solvents in them as they may damage the gauge.

## **- WARNING -**

It is the customer's responsibility to determine the suitability of the carbon filter for any particular application or purpose. The effectiveness of activated carbon must be routinely monitored. In addition, certain substances can combine in the carbon that can result in a fire hazard. Air Quality Engineering, Inc., accepts no liability for the activated carbon effectiveness or fire hazard.

### **CARBON MODULE MAINTENANCE (OPTIONAL)**

The M660 can be ordered with an optional carbon module. This module is refillable.

1. Open the filter access door.
2. Slide the used carbon module out of the filter track that is behind the primary filter track.

Caution – the carbon module weighs approximately 50 lbs. Use appropriate means to support the carbon module during service.

3. Refill the carbon module by removing the cover held on by four screws and pouring out the used carbon in an appropriate container. This used carbon must be reactivated or disposed of in the proper manner. Pour in the new or reactivated carbon and replace the cover and four screws.
4. Slide the module back into the filter track and close the filter access door.

# ELECTRICAL SCHEMATICS

## Single Phase Schematic

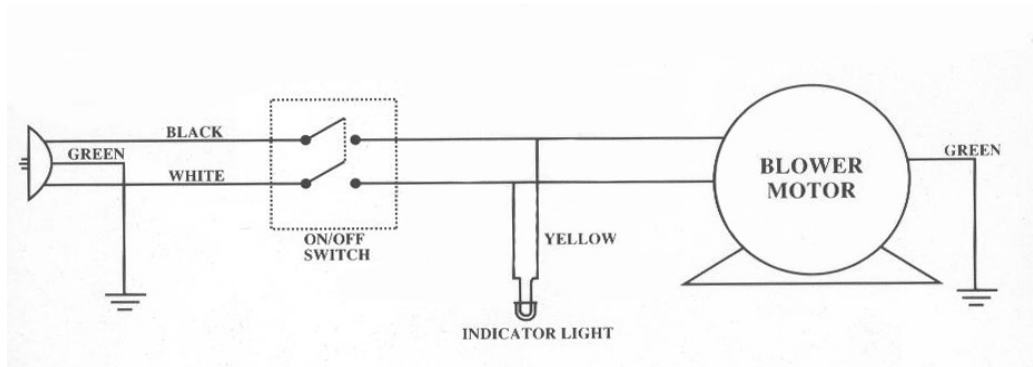

## 3 Phase Schematic

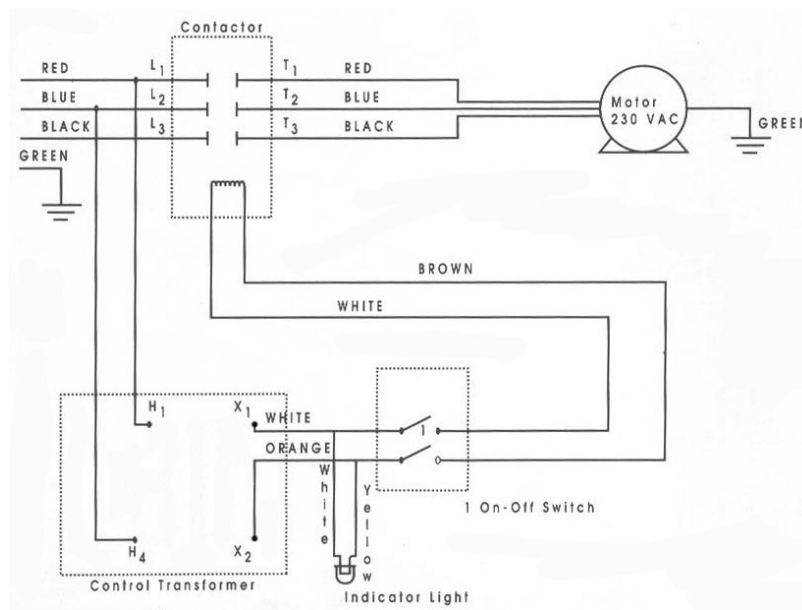

# PARTS IMAGES

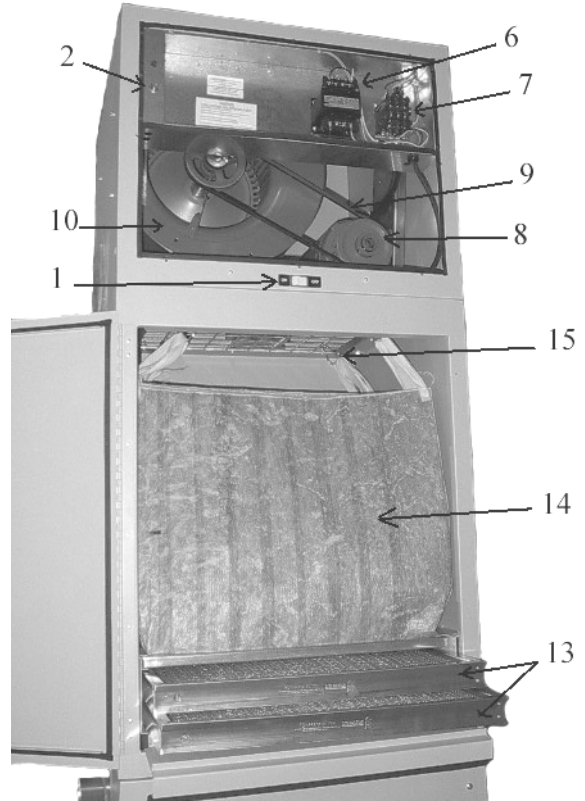

# PARTS LIST

NO.	DESCRIPTION	PART NO.
1	On/Off Switch	10140
2	Indicator Light	10097
3	Dirty Filter Gauge, 3" wg., (red fluid)	10205
3	Dirty Filter Gauge, 7" wg., (blue fluid)	10213
4 (shown on page 9)	MiniHelic 5"	10219
	MiniHelic 10"	10259
5	Terminal Block (single phase only)	30278
Not shown	Red Gauge Oil, ¾ oz.	45025
6	Transformer ( 3 phase only )	10075
7	Relay ( 3 phase only )	10078
8	1 Hp Motor, 208-240V/460V, 3 phase, (belt drive)	40009
8	1 Hp Motor, 120V/208-240V, single phase, (belt drive)	40013
8	1.5 Hp Motor, 120V/208-240V, single phase, (belt drive)	40037
8	2 Hp Motor, 208-240V, single phase, (belt drive)	40039
8	2 Hp Motor, 208-240V/460V, 3 phase, 1750 RPM, (belt drive)	40040
8	3 Hp Motor, 208-240V/460V, 3 phase, 1750 RPM, (belt drive)	40041
9	Blower Sheave and Belt	Call factory
10	Forward Curved Blower (belt drive)	37012
11	2Hp Motor, 208-240V/460V, 3 phase, 3450 RPM, (direct drive)	40071
11	3Hp Motor, 208-240V/460V, 3 phase, 3450 RPM, (direct drive)	40070
12	Backward Inclined Blower and Inlet Cone 2 Hp (direct drive)	37040 & 37036
12	Backward Inclined Blower and Inlet Cone 3 Hp (direct drive)	37035 & 37036
13	Impinger (Qty. 2)	41146
14	Filter ( 95% Mist Bag Filter 24" x 24" x 22")	41101
14	Filter ( 85% Mist Bag Filter 24" x 24" x 22")	41102
14	Filter ( 65% Mist Bag Filter 24" x 24" x 22")	41103
14	Filter ( 50% Mist Bag Filter 24" x 24" x 22")	41104
Not shown	Rigid 95% Filter 24" x 24" x 12"	41186
Not shown	Rigid 85% Filter 24" x 24" x 12"	41187
15	Hook, Filter Bag	30706
16	Polypropylene 95% ESF Filter 24" x 24" x 12"	41218
16	Polypropylene 85% ESF Filter 24" x 24" x 12"	41219
16	Polypropylene 65% ESF Filter 24" x 24" x 12"	41223
Not shown	45 lb. Carbon Module Filter	41077
Not shown	50 lb. Bulk Carbon refill	41165
Not shown	200 lb. Bulk Carbon refill	41081
17	Cap/ Plug Plenum 8"	30032
Not shown	Flex Hose	30021
Not shown	EPDM Rubber Flexible Hose 8" x 18'	30548
Not shown	Flexible Aluminum Ducting 8" x 15'	30680
Not shown	Flexible Aluminum Ducting 8" x 30'	30682
Not shown	Silencer Assembly	05578
Not shown	Impinger Assembly	07057
Not shown	M69 Carbon Module 45 lbs.	07092
Not shown	M68 HEPA Module	07091

# TROUBLE SHOOTING

## WARNING!

The following instructions are intended for qualified service personnel only. Dangerous line voltage circuits are exposed during this procedure. Disconnect the power before servicing the unit.

### Check the Fan Motor and Power Source

If the fan does not run when the switch is on check the voltage supplied to the motor.

If the correct line voltage is not measured, check back through the wiring to the power source.

If the motor does not turn with the correct voltage applied, check to see that the shaft is free to turn.  
Replace the motor, if necessary.

If the fan is noisy when the unit is in operation check the fan.

**WARNING:** Disconnect power before continuing! Manually turn the fan to make sure there is no rubbing or grinding

### Check the Wheel Rotation

Turn on power just long enough to start wheel rotating.

Check rotation for agreement with rotation arrow. Wheels are shown with counterclockwise rotation from inlet side. If the rotation differs from the picture check wiring.

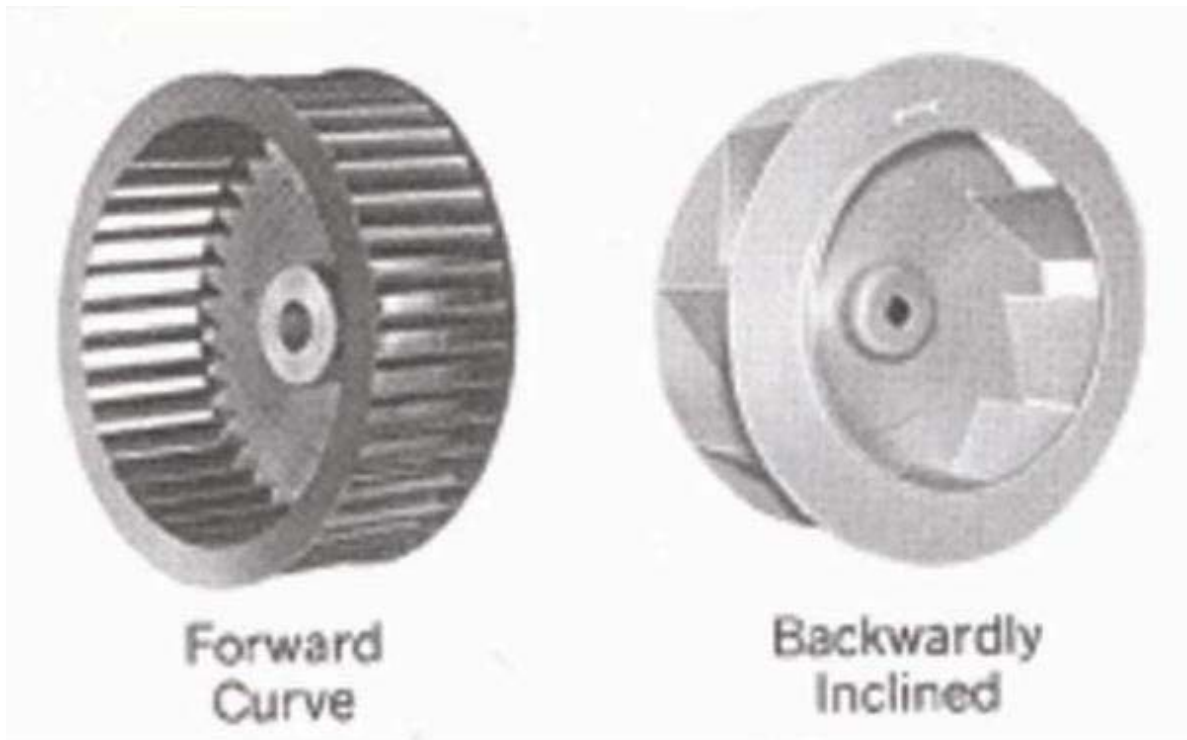

# CERTIFICATE OF WARRANTY

## THREE-YEAR LIMITED WARRANTY

Air Quality Engineering, Inc. (AQE), warrants to the original purchaser, subject to the conditions below, that if the "Product" covered by this warranty should fail to perform by reason of improper workmanship or material, AQE will during the period of three (3) years from the date of original purchase either (i) replace the product or (ii) provide all necessary parts to repair the product without charge. The decision to replace the product or the necessary parts shall rest solely with AQE. This three-year limited warranty does not apply to main filter elements. AQE will replace without charge the main filter elements during the period of thirty (30) days from the date of original purchase if the main filter elements fail to perform by reason of improper workmanship or material. This warranty is valid only under the following conditions:

## CONDITIONS

1. **REGISTRATION:** The purchaser's completion and mailing of the Registration Card to Air Quality Engineering, Inc., 7140 Northland Drive North, Minneapolis, Minnesota 55428-1520 within 30 days of original purchase.
2. **AUTHORIZATION:** The purchaser will contact AQE at (763) 531-9823 for authorization, returned goods number (RGA) and the shipping address. AQE will direct the purchaser to either return the necessary parts or the product at AQE's option.
3. **PROPER DELIVERY:** The shipping, freight prepaid or delivery of the parts or the product to AQE in either its original carton or in a carton assuring similar protection of the product with the returned goods number (RGA) clearly displayed on the outside of the carton.
4. **UNAUTHORIZED REPAIR:** A showing by the original purchaser that the product has not been altered, repaired or serviced by anyone other than an authorized service technician using genuine AQE parts.
5. **UNAUTHORIZED PARTS:** A showing by the original purchaser that the product has had only genuine AQE parts and filters used in its operation and maintenance.
6. **SERIAL NUMBER INTACT:** A showing by the original purchaser that the serial number has not been altered or removed.
7. **MISUSE:** A showing by the original purchaser that the product has not been involved in an accident, freight damaged, misused, abused or operated contrary to the instructions contained in the Owner's Manual.

Air Quality Engineering, Inc.'s, sole responsibility shall be to repair or replace the product within the terms stated above. AQE SHALL NOT BE LIABLE FOR ANY CONSEQUENTIAL DAMAGES RESULTING FROM ANY BREACH OF WARRANTY, EXPRESS OR IMPLIED, APPLICABLE TO THIS PRODUCT. Some states do not allow the exclusion or limitation of consequential damages so this limitation may not apply to you.

THIS WARRANTY IS IN LIEU OF ALL OTHER WARRANTIES, EXPRESS OR IMPLIED, AND THE WARRANTIES OF MERCHANTABILITY AND FITNESS FOR A PARTICULAR PURPOSE ARE HEREBY EXCLUDED BEYOND THE THREE-YEAR DURATION OF THIS WARRANTY. Some states do not allow limitations on how long an implied warranty lasts so the above limitation may not apply to you.

This warranty gives you specific legal rights and you may also have other rights that vary from state to state.

**AIR QUALITY ENGINEERING, INC.**  
**7140 NORTHLAND DRIVE NORTH**  
**MINNEAPOLIS, MINNESOTA 55428-1520**

**TOLL FREE: 1-800-328-0787**  
**TELEPHONE: (763) 531-9823**  
**FAX: (763) 531-9900**

MANUFACTURER & WORLDWIDE DISTRIBUTOR OF SMOKEMASTER® AIR CLEANING SYSTEMS

Printed in the USA